

Article number: 201580M1050PL

Description: E+G Screw GN 1580-M10-50-PL-H
Hygienic design

Measures

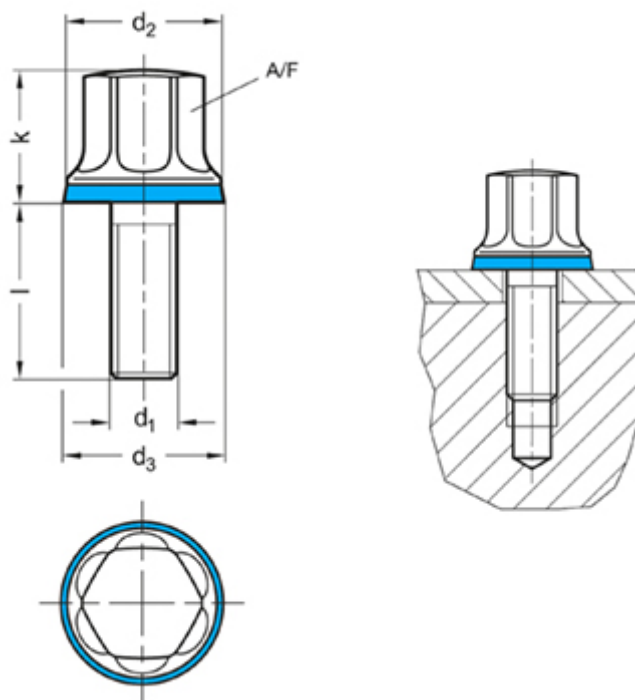

d1	= M 10
d2	= 21
d3	= 21.8
k	= 18
L	= 50
t min	= -
Weight in (g)	= 55